

SPECIFICATIONS

DIAMETER: 5.25" (130MM)
 SENSITIVITY: 89.7 dB
 POWER HANDLING: 20 WRMS (100W PK)
 FREQUENCY RESPONSE: 80 ~ 7000 HZ
 NOMINAL IMPEDANCE: 4 OHMS
 VOICE COIL DIAMETER: 1.0" (26MM)
 DIMENSIONS:

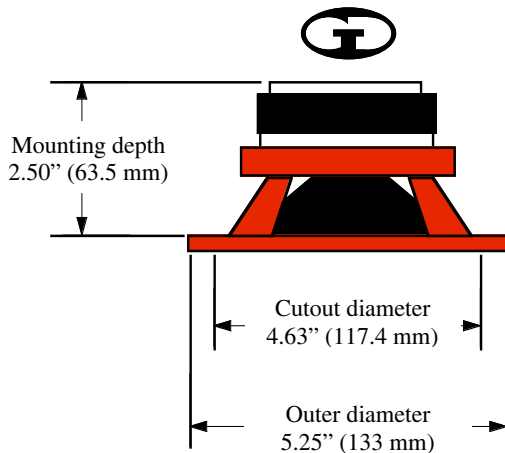

THIELE-SMALL PARAMTERS

FREE AIR RESONANCE: 81.72 Hz
 VOICE COIL DC RESISTANCE: 3.25 OHMS
 VOICE COIL INDUCTANCE @ 1 kHz: 0.22 mH
 MECHANICAL Q (Q_{MS}): 5.95
 ELECTRICAL Q (Q_{ES}): 1.12
 TOTAL Q (Q_{TS}): 0.95
 COMPLIANCE VOLUME (V_{AS}): 4.01 L
 0.1414 FT³
 MOVING MASS, DIAPHRAGM: 11.99 GR
 DRIVER RADIATING AREA (S_D): 95 CM²
 14.72 IN²
 MOTOR FORCE FACTOR: 4.22 TM

NOTE:
 ALL SEALED BOXES GREATER THAN 0.5 CUBIC FEET ARE USEABLE BUT THE RESPONSE EFFECTS WILL SUIT SPECIAL PURPOSES. USABLY SMALL ENCLOSURE SETUP FOR BASS IN A MEDIUM SIZE CAB IS SHOWN HERE.

**Box Volume = 0.50 CU. Ft.
 (14.17 LITERS) SEALED**

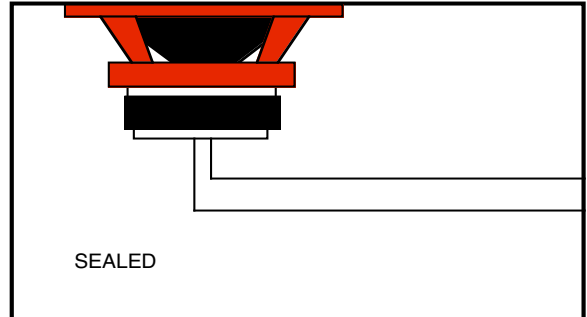

**SEALED BOX
 FREQUENCY RESPONSE @ 10 WATTS**

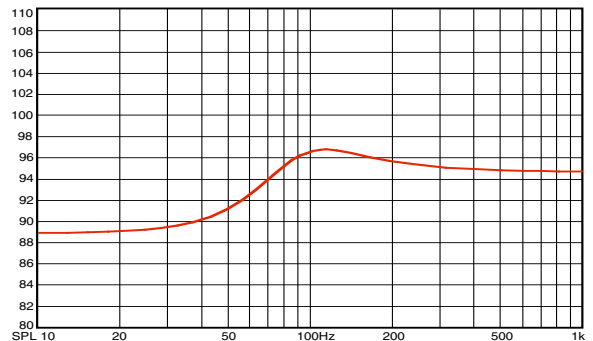

**DOOR VOLUME = 1.0CU. Ft.
 (28.35 LITERS)**

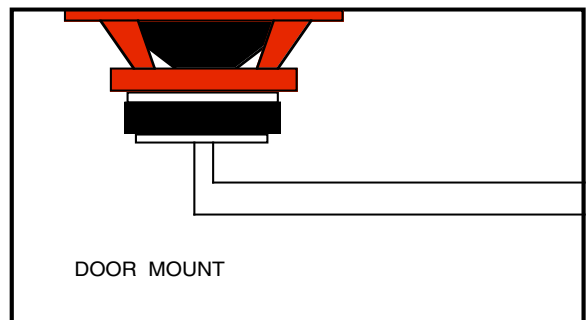

**DOOR MOUNT
 FREQUENCY RESPONSE @ 10 WATTS**

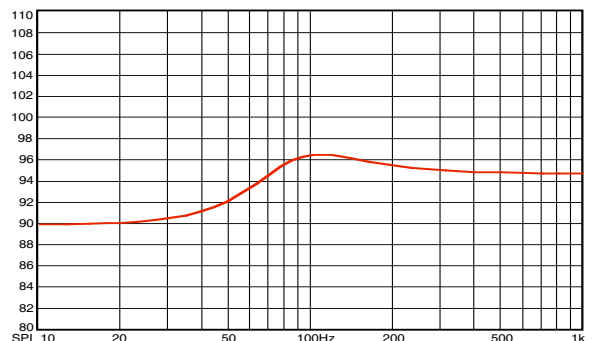

**BOX VOLUME = 0.35 CU. FT. (9.92 LITERS)
TUNED TO 55HZ PORT = 2"D X 6.56"L**

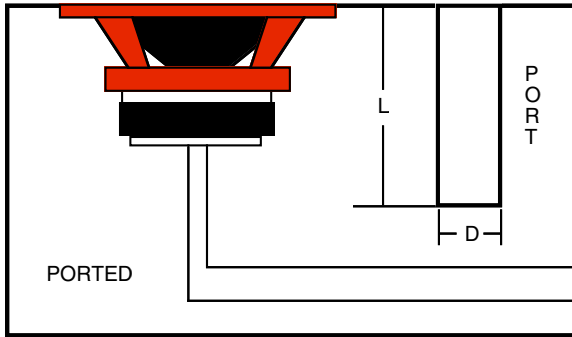

**PORTED BOX
FREQUENCY RESPONSE @ 10 WATTS**

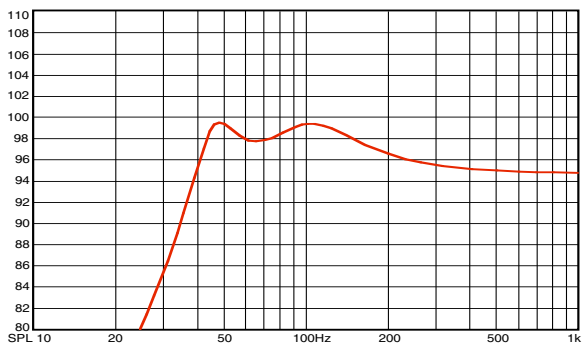

**BOX RESPONSE FOR SPECIAL
EFFECT SHOWN.**